

03



TIC Series LINEAR MOTOR WITH IRON CORE

Intro

The iron-core linear motor consists of two parts: a single row of magnet yokes and a rotor assembly. The rotor part is made up of copper coils wound around the iron core. The base plate provides an efficient path for magnetic flux circulation between the motor and the magnetic track, and it also serves as an effective means of heat dissipation for the motor. Special electromagnetic design is used to achieve the required technical parameters. This type of motor offers high thrust, making it particularly suitable for applications requiring large loads and high motion rigidity.

Advantages

- ❶ The iron core structure concentrates magnetic flux, allowing for high thrust output.
- ❷ The cost is relatively low, and the iron core design is inexpensive.
- ❸ The iron core facilitates heat dissipation, enabling high power in full-load applications.

Disadvantages

- ❶ The high magnetic attraction requires strict assembly standards.
- ❷ There is cogging effect, which impacts motion smoothness, fluctuations, and settling error. Motion control is relatively complex.

Application Industry

3C industry (Computers, Communication, Consumer electronics)
 Semiconductor industry New energy industry
 Automotive industry Photovoltaic industry
 LCD panel industry Laser processing industry

Linear motor selection:

- The selection of a linear motor involves calculating the requirements for maximum thrust and continuous thrust.
- In accelerated linear motion, the force $F=ma$, where F is the force required to move the load (in Newtons), m is the mass of the moving object (in kilograms), and a is the acceleration (in meters per second squared). The maximum thrust is determined by the mass of the moving load and the maximum acceleration. In practical applications, thrust = total mass × acceleration + friction + external resistance.
For example: (Assuming no friction or external resistance) For a moving load of 10 kg (including the rotor) and an acceleration of 10 m/s^2 , the motor would need to generate a force of 100 N.
- Typically, the actual acceleration requirement is unknown, but the operating time is given. With a known travel distance and required time, the acceleration can be calculated. For short travel distances, a triangular velocity profile (without a constant speed phase) is recommended. For longer travel distances, a trapezoidal velocity profile is recommended.
- Triangular Velocity Profile: $a = \frac{4S}{t^2}$
Where S is the travel distance, stroke, and t is the time.

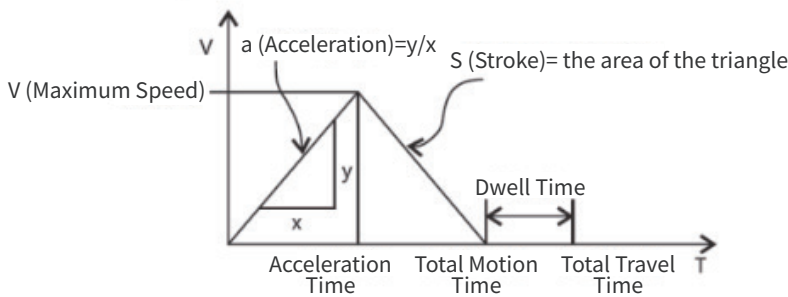

- Trapezoidal Profile: The preset constant velocity can determine the acceleration:
Acceleration = Constant velocity / (Total time - Dwell time - Displacement / Constant velocity)

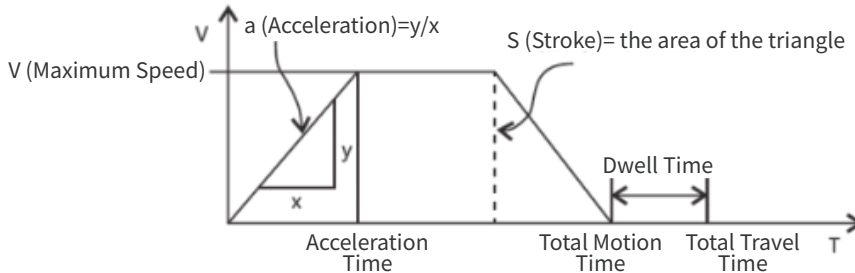

- Deceleration is calculated similarly to acceleration, unless there is an unbalanced force (such as gravity) acting on the motor.
- To maintain constant velocity and during the dwell phase, friction and external resistance also need to be considered. (To maintain constant velocity, the motor will overcome friction and external resistance, and during servo dwell, the motor will overcome external resistance.)
- The formula for calculating continuous thrust is as follows:

$$\text{Continuous Thrust} = \sqrt{\frac{Fa^2 \times Ta + Fc^2 \times Tc + Fd^2 \times Td + Fw^2 \times Tw}{Ta + Tc + Td + Tw}}$$

	force	duration
Acceleration Phase	Fa	Ta
Constant Velocity Phase	Fc	Tc
Deceleration Phase	Fd	Td
Dwell Phase	Fw	Tw

- When selecting a motor based on maximum thrust and continuous thrust, a safety factor of 20-30% should be set to overcome friction and external resistance.

TIC series with iron core linear motor Order specifications:

Coil Model:

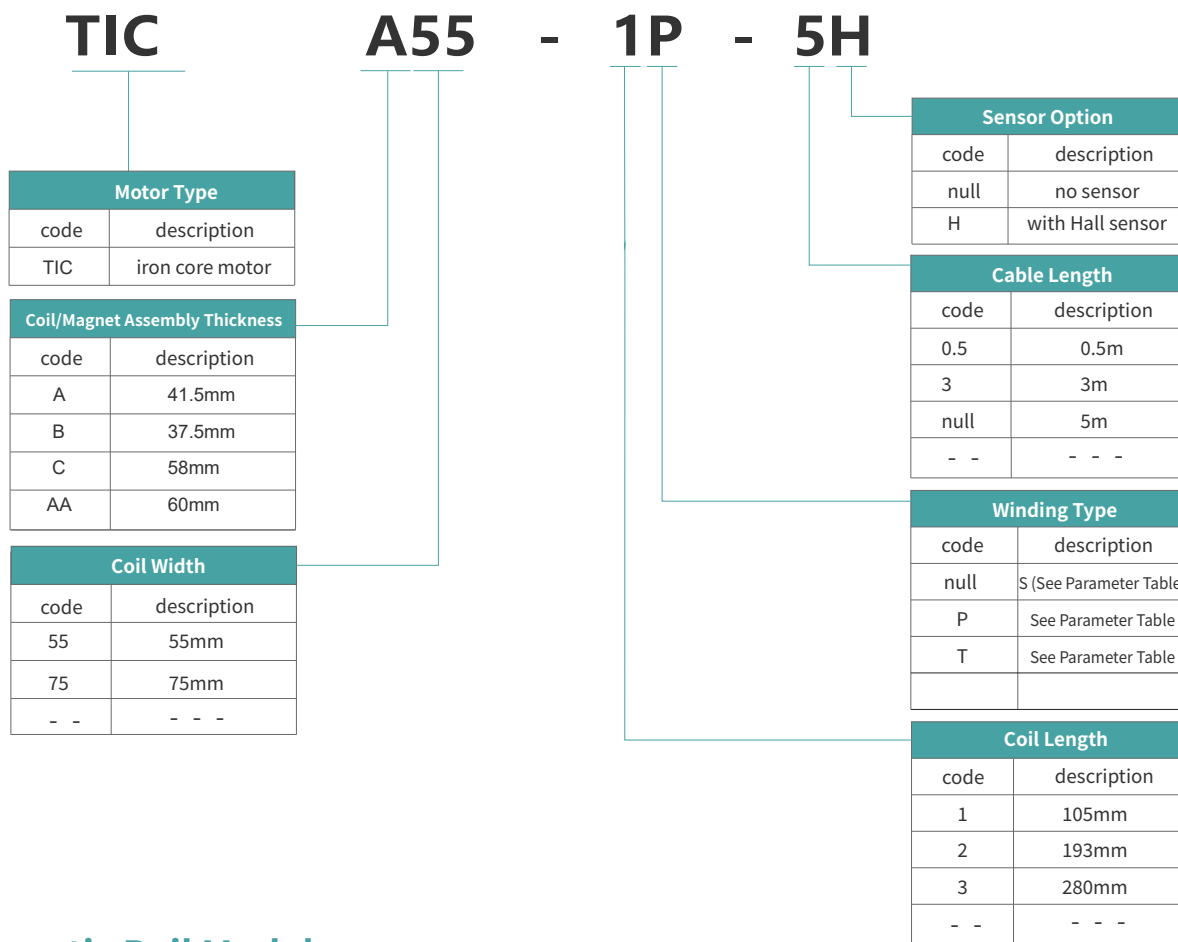

Magnetic Rail Model:

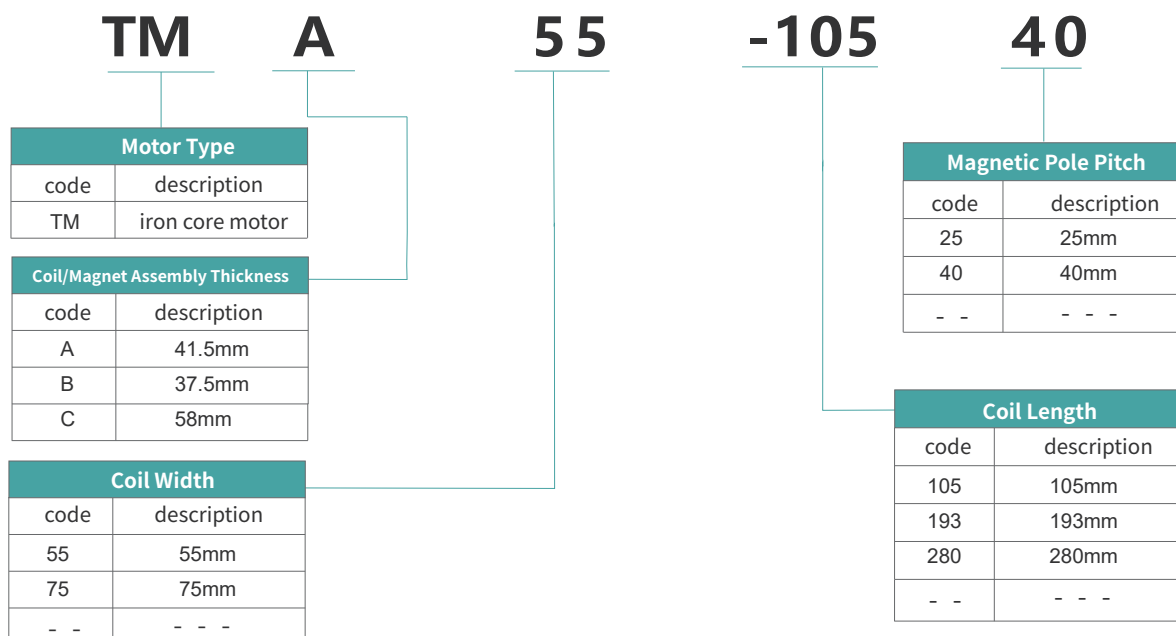

TLM series

TSLM series

TIC series

TU series

TICA35 series with iron core

34.3mm
Height

35mm
width

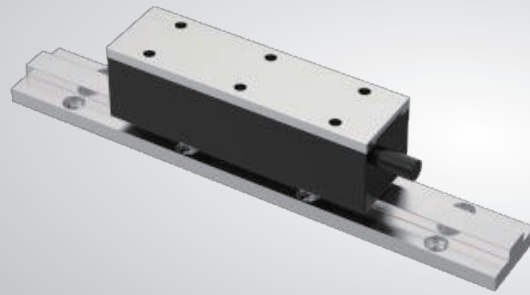

Continuous thrust **48N~144N**

Peak thrust **138N~414N**

Temperature rise **< 0.05°C/W**

Thrust fluctuation **< 2%**

Product parameter

Motor Model	TICA35-1	TICA35-2	TICA35-3
Winding Code	S	S	S
Performance Parameters			
Maximum Thrust (N)	138	276	414
Continuous Thrust (N)	48	96	144
Maximum Power (W)	208	416	624
Continuous Power (W)	72	144	216
Forward Attraction Force (N)	312	624	936
Electrical Characteristics			
Maximum Current (Arms)	10.34	10.34	10.34
Continuous Current (Arms)	3.39	3.39	3.39
Thrust Constant (N/Arms)	61.36	28.32	42.48
Back EMF (Vpeak/m/s)	13.4	40.63	40.63
Line Resistance (Ohms)	1.91	3.47	5.03
Line Inductance (mH)	7.3	14.6	21.9
Time Constant (ms)	3.82	4.21	4.35
Motor Constant (N/√W)	29.6	12.41	15.46
Maximum Coil Temperature (°C)	100	100	100
Maximum Terminal Voltage (VDC)	310	310	310
Mechanical Characteristics			
Mover Length (mm)	105	193	280
Mover Mass (kg)	0.54	1.08	1.62
Stator Mass (kg/m)	2	2	2
Magnetic Pole Pitch (mm)	25	25	25

Motor outline

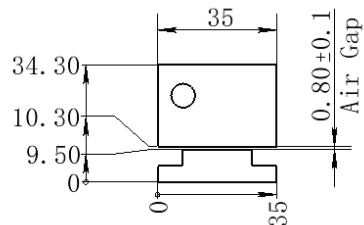
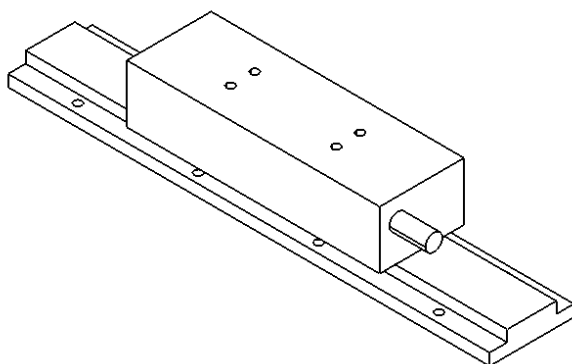

Coil profile

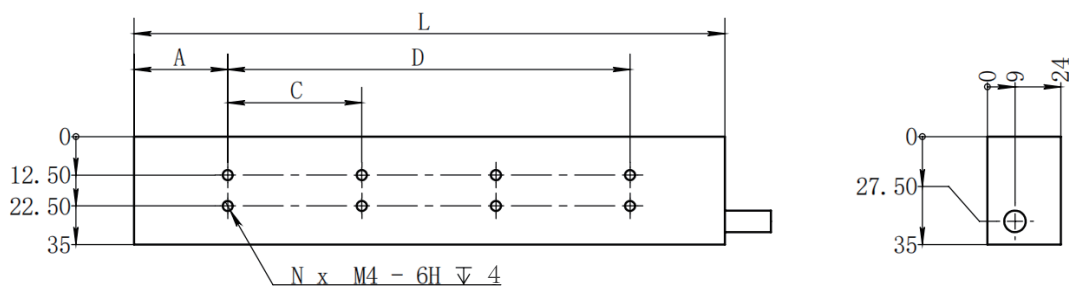

(单位:mm)	A	C	D	L	N
TICA35-1	30.6	43.8	43.8	105	4
TICA35-2	30.8	43.8	131.4	193	8
TICA35-3	30.5	43.8	291	280	12

Track profile

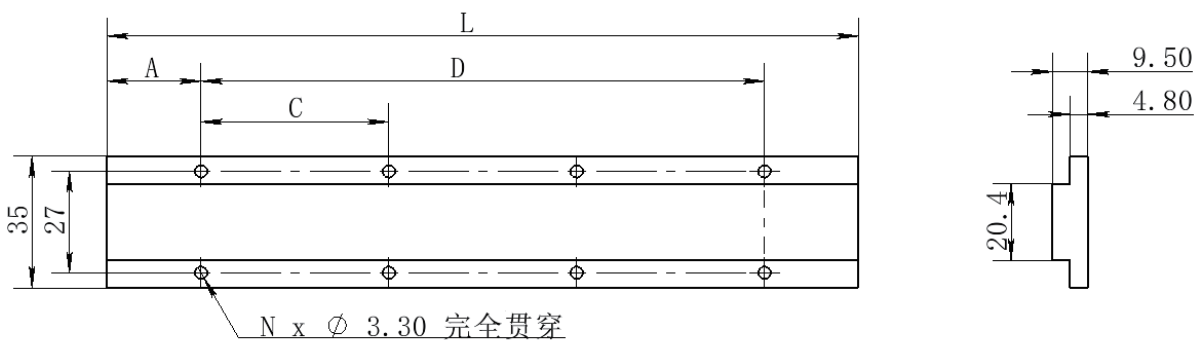

(单位:mm)	A	C	D	L	N
TMA35-150	25	50	100	150	6
TMA35-200	25	50	150	200	8
TMA35-250	25	50	200	250	10

TLM series

TSLM series

TIC series

TU series

TICA40 series with iron core

34.3mm
Height

40mm
width

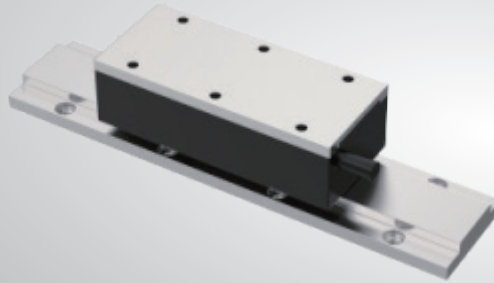

Continuous thrust **60N~180N**

Peak thrust **173N~519N**

Temperature rise **< 0.05°C/W**

Thrust fluctuation **< 2%**

Product parameter

Motor Model	TICA40-1	TICA40-2	TICA40-3
Winding Code	S	S	S
Performance Parameters			
Maximum Thrust (N)	173	346	519
Continuous Thrust (N)	60	120	180
Maximum Power (W)	260	520	780
Continuous Power (W)	90	180	270
Forward Attraction Force (N)	379	758	1137
Electrical Characteristics			
Maximum Current (Arms)	10.37	10.37	10.37
Continuous Current (Arms)	3.4	3.4	3.4
Thrust Constant (N/Arms)	17.58	35.16	52.74
Back EMF (Vpeak/m/s)	16.73	33.46	50.19
Line Resistance (Ohms)	1.83	3.66	5.49
Line Inductance (mH)	8.37	16.74	25.11
Time Constant (ms)	4.58	4.58	4.58
Motor Constant (N/√W)	10.65	15.06	18.45
Maximum Coil Temperature (°C)	130	130	130
Maximum Terminal Voltage (VDC)	310	310	310
Mechanical Characteristics			
Mover Length (mm)	105	193	280
Mover Mass (kg)	0.5	0.8	2.6
Stator Mass (kg/m)	2	2	2
Magnetic Pole Pitch (mm)	25	25	25

Motor outline

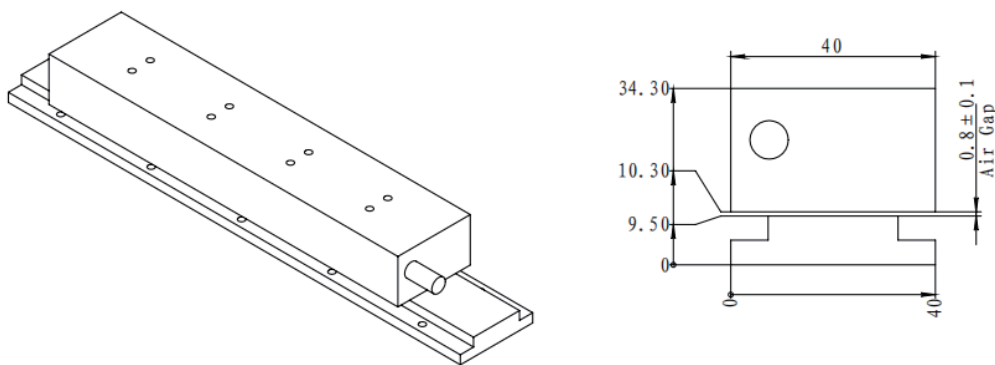

Coil profile

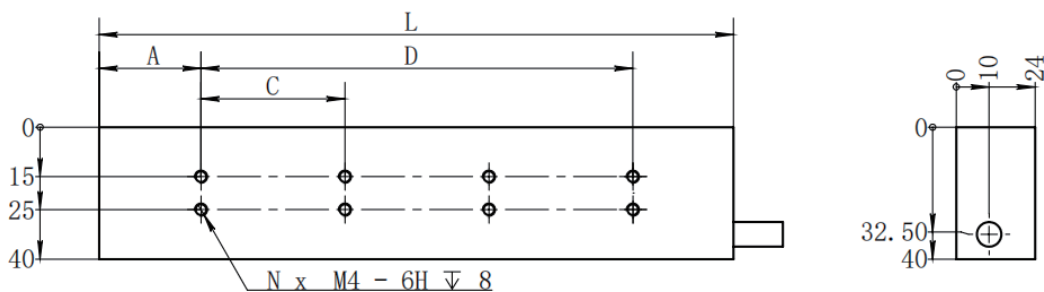

(単位:mm)	A	C	D	L	N
TICA40-1	30.6	43.8	43.8	105	4
TICA40-2	30.8	43.8	131.4	193	8
TICA40-3	30.5	43.8	219	280	12

Track profile

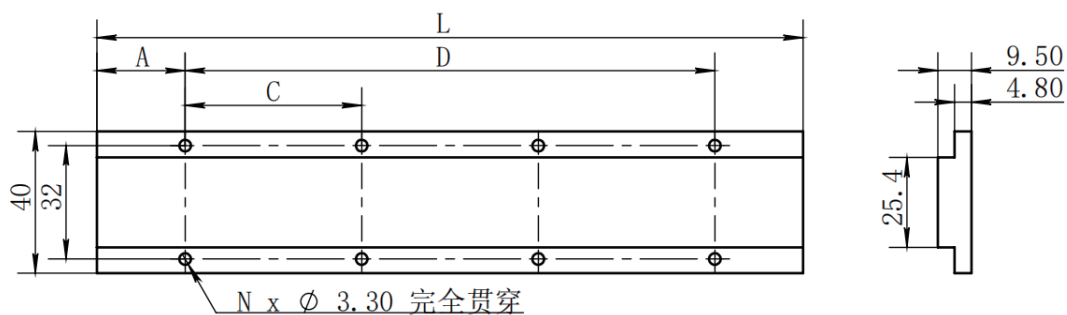

(単位:mm)	A	C	D	L	N
TMA40-150	25	50	100	150	6
TMA40-200	25	50	150	200	8
TMA40-250	25	50	200	250	10

TLM series

TSLM series

TIC series

TU series

TICA55 series with iron core

41.5mm
Height

55mm
width

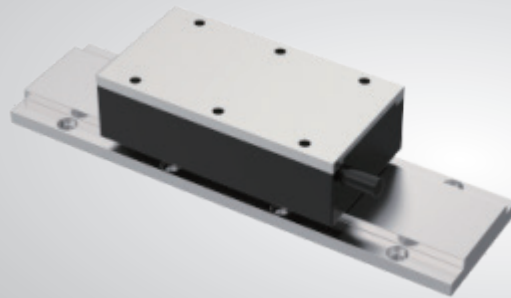

Continuous thrust **91N~273N**

Peak thrust **252N~756N**

Temperature rise **< 0.05°C/W**

Thrust fluctuation **< 2%**

Product parameter

Motor Model	TICA55-1		TICA55-2		TICA55-3	
Winding Code	S	S	P	S	T	
Performance Parameters						
Maximum Thrust (N)	252	504	504	756	756	
Continuous Thrust (N)	91	182	182	273	273	
Maximum Power (W)	396	792	792	1188	1188	
Continuous Power (W)	137	274	274	411	411	
Forward Attraction Force (N)	530	1060	1060	1590	1590	
Electrical Characteristics						
Maximum Current (Arms)	10.31	10.31	20.62	10.31	30.93	
Continuous Current (Arms)	3.38	3.38	6.76	3.38	10.14	
Thrust Constant (N/Arms)	26.92	53.84	26.92	80.76	26.92	
Back EMF (Vpeak/m/s)	23.42	46.84	23.42	70.26	23.42	
Line Resistance (Ohms)	2.53	5.06	1.27	7.59	0.84	
Line Inductance (mH)	11.6	23.2	5.8	34.8	3.87	
Time Constant (ms)	4.58	4.58	4.58	4.58	4.58	
Motor Constant (N/√W)	13.82	19.54	19.54	23.94	23.94	
Maximum Coil Temperature (°C)	130	130	130	130	130	
Maximum Terminal Voltage (VDC)	310	310	310	310	310	
Mechanical Characteristics						
Mover Length (mm)	105	193	193	280	280	
Mover Mass (kg)	0.9	1.3	1.3	1.7	1.7	
Stator Mass (kg/m)	3.6	3.6	3.6	3.6	3.6	
Magnetic Pole Pitch (mm)	25	25	25	25	25	

Motor outline

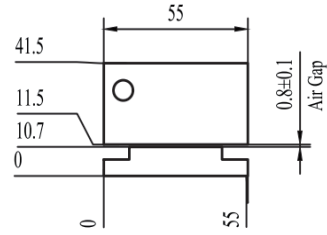
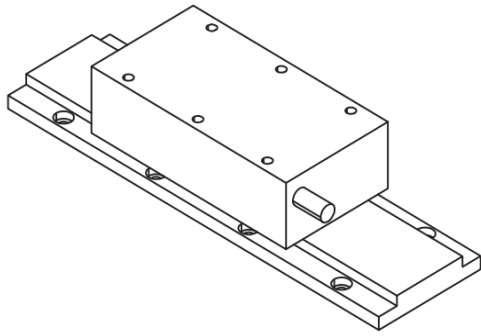

Coil profile

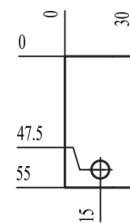
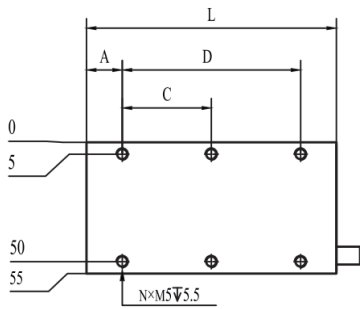

(単位:mm)	A	C	D	L	N
TICA55-1	15	37.5	75	105	6
TICA55-2	16.5	40	160	193	10
TICA55-3	20	40	240	280	14

Track profile

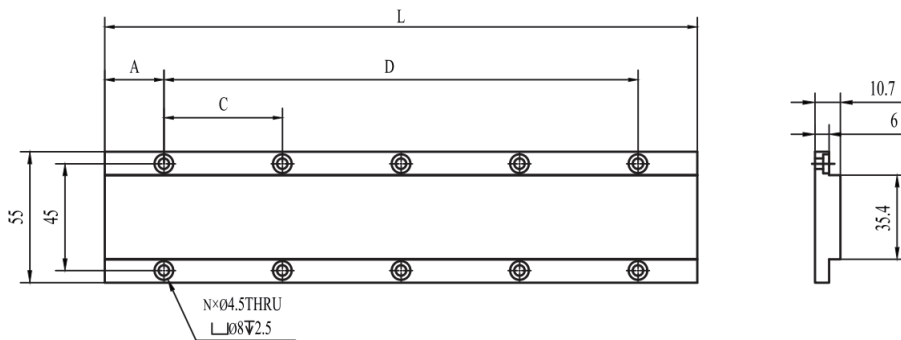

(単位:mm)	A	C	D	L	N
TMA55-150	25	50	100	150	6
TMA55-200	25	50	150	200	8
TMA55-250	25	50	200	250	10

TICAA55 series with iron core

60mm
Height

55mm
width

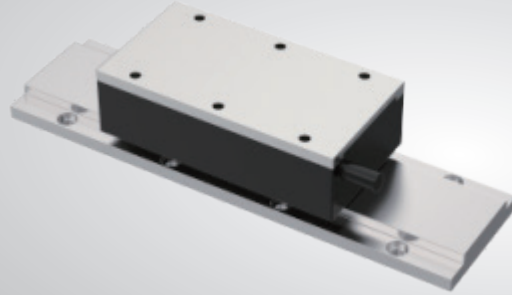

Continuous thrust **118N~471N**

Peak thrust **270N~1073N**

Temperature rise **< 0.05°C/W**

Thrust fluctuation **< 2%**

Product parameter

Motor Model	TICAA55-1	TICAA55-2	TICAA55-4
Winding Code	S	S	S
Performance Parameters			
Maximum Thrust (N)	270	541	1073
Continuous Thrust (N)	118	238	471
Maximum Power (W)	405	812	1609
Continuous Power (W)	178	357	707
Forward Attraction Force (N)	423	846	1691
Electrical Characteristics			
Maximum Current (Arms)	8.9	8.93	17.7
Continuous Current (Arms)	2.78	2.79	5.53
Thrust Constant (N/Arms)	42.6	85.19	85.19
Back EMF (Vpeak/m/s)	36.78	73.18	73.31
Line Resistance (Ohms)	4.19	8.37	4.15
Line Inductance (mH)	55.29	110.24	53.97
Time Constant (ms)	13.21	13.17	13.01
Motor Constant (N/√W)	17	24.04	34.16
Maximum Coil Temperature (°C)	130	130	130
Maximum Terminal Voltage (VDC)	310	310	310
Mechanical Characteristics			
Mover Length (mm)	105	198	380
Mover Mass (kg)	1.7	2.7	4.3
Stator Mass (kg/m)	3.6	3.6	3.6
Magnetic Pole Pitch (mm)	25	25	25

Motor outline

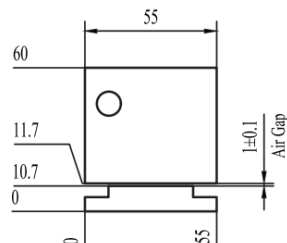
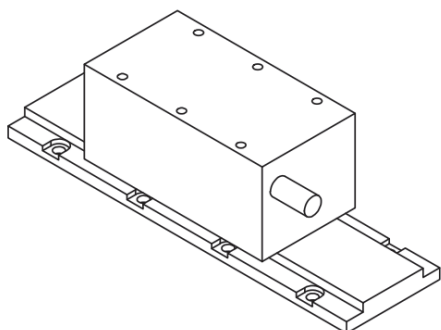

Coil profile

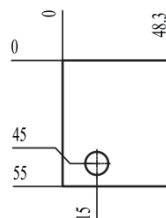
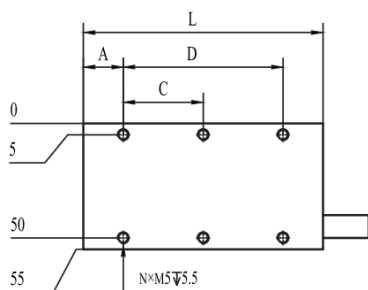

(単位:mm)	A	C	D	L	N
TICAA55-1	17.5	35	70	105	6
TICAA55-2	11.5	35	175	198	12
TICAA55-3	15	35	350	380	22

Track profile

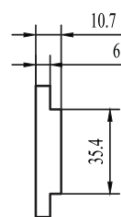
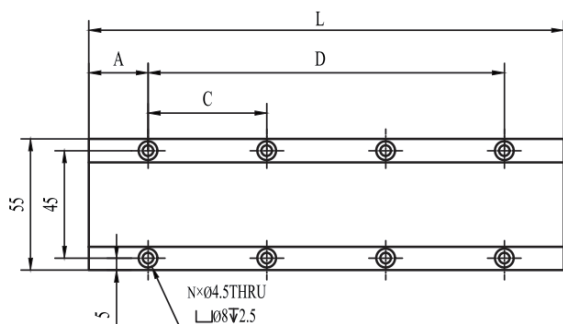

(単位:mm)	A	C	D	L	N
TMA55-150	25	50	100	150	6
TMA55-200	25	50	150	200	8
TMA55-250	25	50	200	250	10

TLM series

TSLM series

TIC series

TU series

TICA75 series with iron core

41.5mm
Height

75mm
width

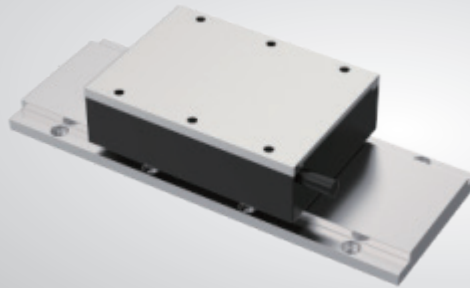

Continuous thrust **138N~414N**

Peak thrust **371N~1113N**

Temperature rise **< 0.05°C/W**

Thrust fluctuation **< 2%**

Product parameter

Motor Model	TICA75-1		TICA75-2		TICA75-3	
Winding Code	S	S	P	S	T	
Performance Parameters						
Maximum Thrust (N)	371	742	742	1113	1113	
Continuous Thrust (N)	138	276	276	414	414	
Maximum Power (W)	557	1114	1114	1671	1671	
Continuous Power (W)	207	414	414	621	621	
Forward Attraction Force (N)	640	1280	1280	1920	1920	
Electrical Characteristics						
Maximum Current (Arms)	10.31	10.31	20.62	10.31	30.93	
Continuous Current (Arms)	3.23	3.23	6.46	3.23	9.69	
Thrust Constant (N/Arms)	41.57	83.14	41.57	124.71	41.57	
Back EMF (Vpeak/m/s)	36.7	73.4	36.7	110.1	36.7	
Line Resistance (Ohms)	3.41	6.82	1.71	10.23	1.14	
Line Inductance (mH)	15.66	31.32	7.83	46.98	5.22	
Time Constant (ms)	4.59	4.59	4.59	4.59	4.59	
Motor Constant (N/√W)	18.89	26.72	26.72	32.72	32.72	
Maximum Coil Temperature (°C)	130	130	130	130	130	
Maximum Terminal Voltage (VDC)	310	310	310	310	310	
Mechanical Characteristics						
Mover Length (mm)	105	193	193	280	280	
Mover Mass (kg)	1.16	2.1	2.1	2.5	2.5	
Stator Mass (kg/m)	5.1	5.1	5.1	5.1	5.1	
Magnetic Pole Pitch (mm)	25	25	25	25	25	

Motor outline

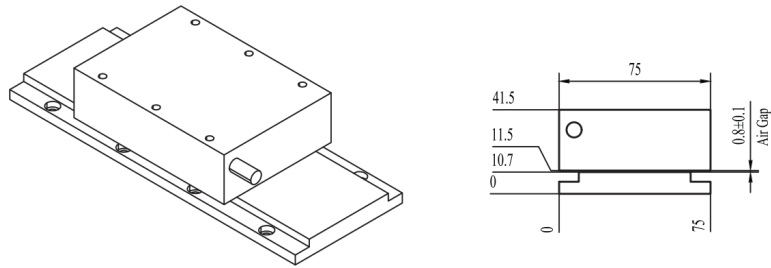

Coil profile

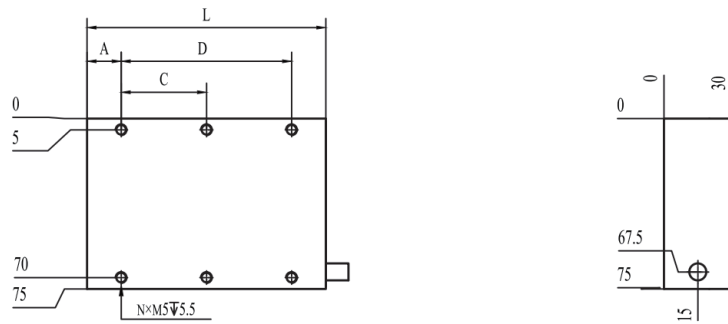

(単位:mm)	A	C	D	L	N
TICA75-1	15	37.5	75	105	6
TICA75-2	16.5	40	160	193	10
TICA75-3	20	40	240	280	14

Track profile

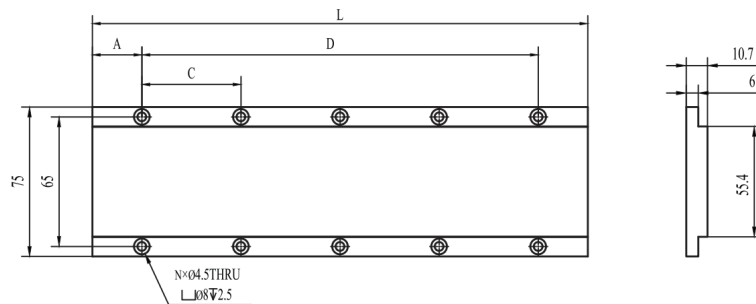

(単位:mm)	A	C	D	L	N
TMA75-150	25	50	100	150	6
TMA75-200	25	50	150	200	8
TMA75-250	25	50	200	250	10

TLM series

TSLM series

TIC series

TU series

TICAA75 series with iron core

60mm
Height

75mm
width

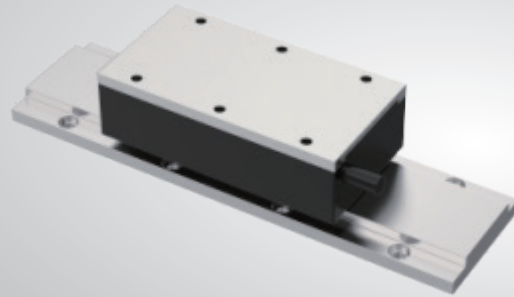

Continuous thrust **186N~739N**

Peak thrust **413N~1652N**

Temperature rise **< 0.05°C/W**

Thrust fluctuation **< 2%**

Product parameter

Motor Model	TICAA75-1	TICAA75-2	TICAA75-4
Winding Code	S	S	FSP
Performance Parameters			
Maximum Thrust (N)	413	826	1652
Continuous Thrust (N)	186	370	739
Maximum Power (W)	1240	2478	4956
Continuous Power (W)	557	1109	2217
Forward Attraction Force (N)	665	1329	2658
Electrical Characteristics			
Maximum Current (Arms)	8.68	8.67	17.33
Continuous Current (Arms)	2.78	2.77	5.52
Thrust Constant (N/Arms)	66.79	133.57	133.88
Back EMF (Vpeak/m/s)	57.8	115	115.2
Line Resistance (Ohms)	5.4	10.80	5.4
Line Inductance (mH)	68.54	137.08	57.04
Time Constant (ms)	12.69	12.69	10.56
Motor Constant (N/√W)	20.33	28.74	40.74
Maximum Coil Temperature (°C)	130	130	130
Maximum Terminal Voltage (VDC)	310	310	310
Mechanical Characteristics			
Mover Length (mm)	105	198	380
Mover Mass (kg)	2.1	3.8	6.5
Stator Mass (kg/m)	5.1	5.1	5.1
Magnetic Pole Pitch (mm)	25	25	25

Motor outline

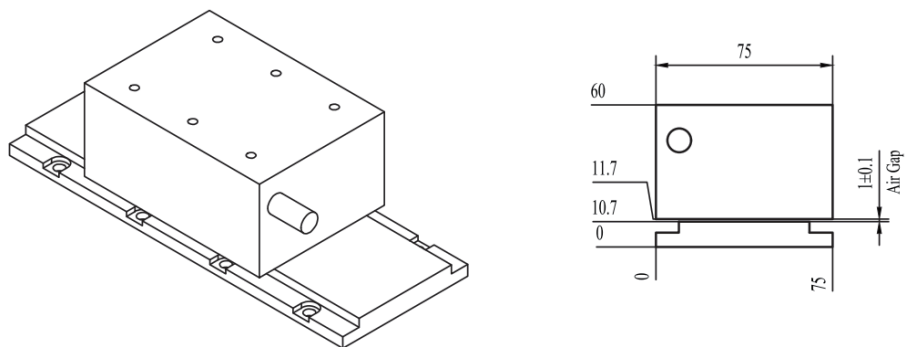

Coil profile

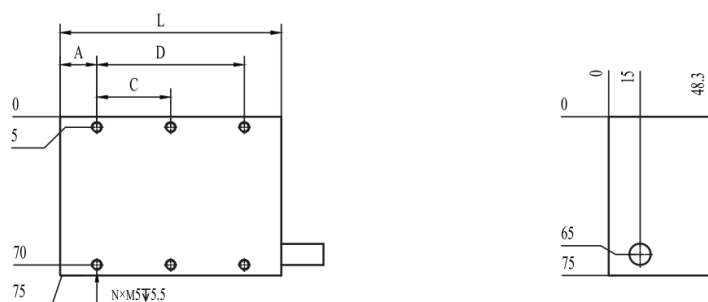

(単位:mm)	A	C	D	L	N
TICAA75-1	17.5	35	70	105	6
TICAA75-2	11.5	35	175	198	12
TICAA75-3	15	35	350	380	22

Track profile

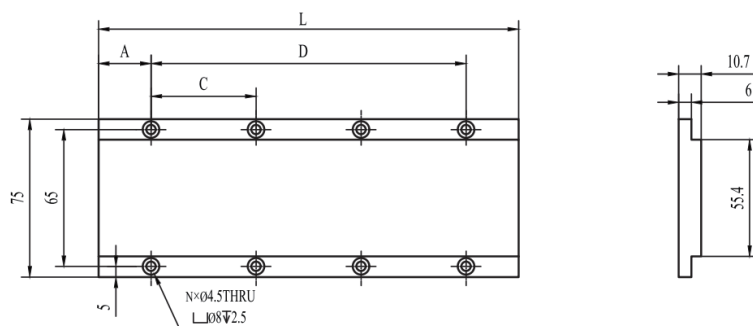

(単位:mm)	A	C	D	L	N
TMAA75-150	25	50	100	150	6
TMAA75-200	25	50	150	200	8
TMAA75-250	25	50	200	250	10

TLM series

TSLM series

TIC series

TU series

TICA95 series with iron core

41.5mm
Height

95mm
width

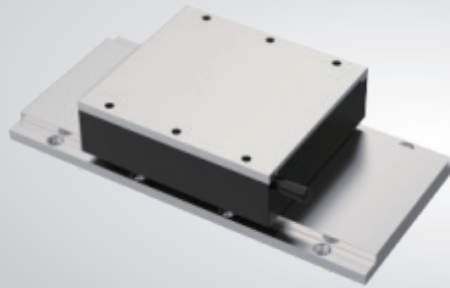

Continuous thrust **189N~567N**

Peak thrust **522N~1566N**

Temperature rise **< 0.05°C/W**

Thrust fluctuation **< 2%**

Product parameter

Motor Model	TICA95-1		TICA95-2		TICA95-3	
Winding Code	S	S	P	S	T	
Performance Parameters						
Maximum Thrust (N)	522	1044	1044	1566	1566	
Continuous Thrust (N)	189	378	378	567	567	
Maximum Power (W)	783	1566	1566	2349	2349	
Continuous Power (W)	283	566	566	849	849	
Forward Attraction Force (N)	873	1746	1746	2619	2619	
Electrical Characteristics						
Maximum Current (Arms)	10.3	10.3	20.6	10.3	30.9	
Continuous Current (Arms)	3.28	3.28	6.56	3.28	9.84	
Thrust Constant (N/Arms)	56.84	113.68	56.84	170.52	56.84	
Back EMF (Vpeak/m/s)	50.18	100.36	50.18	150.54	50.18	
Line Resistance (Ohms)	4.29	8.58	2.15	12.87	1.43	
Line Inductance (mH)	23.6	47.2	11.8	70.8	7.87	
Time Constant (ms)	5.5	5.5	5.5	5.5	5.5	
Motor Constant (N/√W)	22.72	32.12	32.12	39.34	39.34	
Maximum Coil Temperature (°C)	130	130	130	130	130	
Maximum Terminal Voltage (VDC)	310	310	310	310	310	
Mechanical Characteristics						
Mover Length (mm)	105	193	193	280	280	
Mover Mass (kg)	1.52	2.8	2.8	3.6	3.6	
Stator Mass (kg/m)	6.6	6.6	6.6	6.6	6.6	
Magnetic Pole Pitch (mm)	25	25	25	25	25	

Motor outline

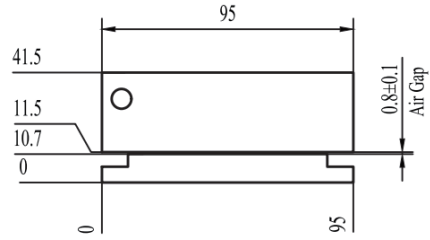
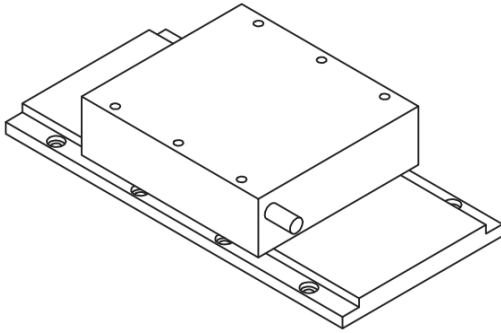

Coil profile

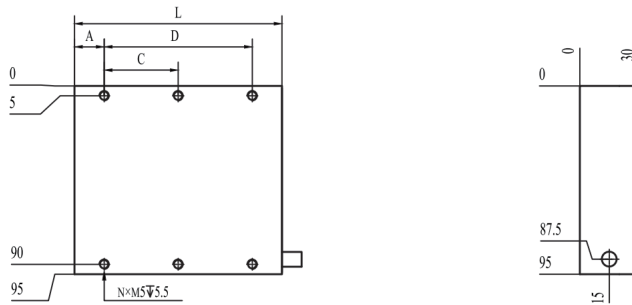

(単位:mm)	A	C	D	L	N
TICA95-1	15	37.5	75	105	6
TICA95-2	16.5	40	160	193	10
TICA95-3	20	40	240	280	14

Track profile

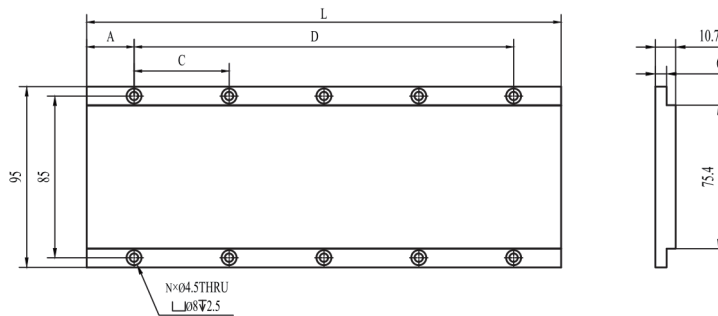

(単位:mm)	A	C	D	L	N
TMA95-150	25	50	100	150	6
TMA95-200	25	50	150	200	8
TMA95-250	25	50	200	250	10

TICAA95 series with iron core

60mm
Height

95mm
width

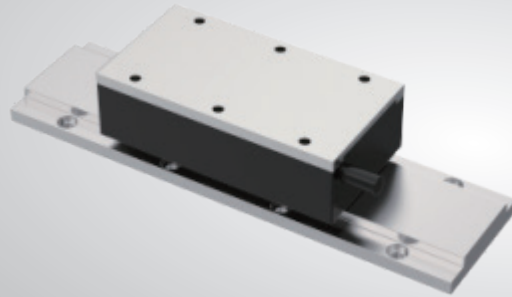

Continuous thrust **252N~1005N**

Peak thrust **564N~2250N**

Temperature rise **< 0.05°C/W**

Thrust fluctuation **< 2%**

Product parameter

Motor Model	TICAA95-1	TICAA95-2	TICAA95-4	
Winding Code	S	S	FSP	P
Performance Parameters				
Maximum Thrust (N)	564	1128	2250	2250
Continuous Thrust (N)	252	504	1005	1005
Maximum Power (W)	1693	3386	6750	6750
Continuous Power (W)	756	1512	3014	3014
Forward Attraction Force (N)	906	1812	3625	3625
Electrical Characteristics				
Maximum Current (Arms)	8.69	8.69	17.32	34.76
Continuous Current (Arms)	2.77	2.77	5.52	11.08
Thrust Constant (N/Arms)	91.07	182.14	182.15	91.07
Back EMF (Vpeak/m/s)	78.82	157.64	157.09	78.82
Line Resistance (Ohms)	7.36	14.72	7.36	1.84
Line Inductance (mH)	93.46	186.92	93.46	23.37
Time Constant (ms)	12.69	12.69	12.69	12.69
Motor Constant (N/√W)	23.74	33.57	33.57	23.74
Maximum Coil Temperature (°C)	130	130	130	130
Maximum Terminal Voltage (VDC)	310	310	310	310
Mechanical Characteristics				
Mover Length (mm)	105	198	380	380
Mover Mass (kg)	2.9	5.1	8.4	8.4
Stator Mass (kg/m)	6.6	6.6	6.6	6.6
Magnetic Pole Pitch (mm)	25	25	25	25

Motor outline

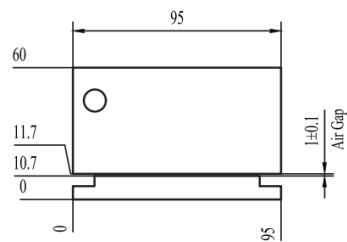
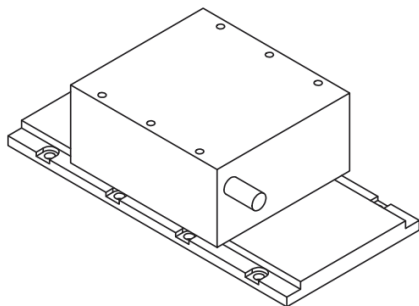

Coil profile

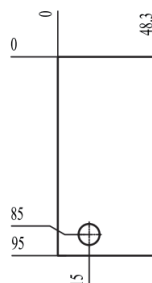
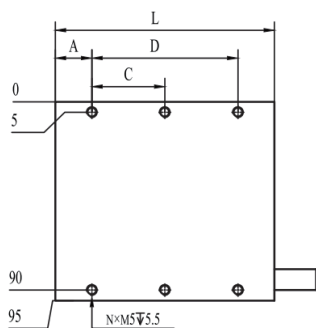

(単位:mm)	A	C	D	L	N
TICAA95-1	17.5	35	70	105	6
TICAA95-2	11.5	35	175	198	12
TICAA95-3	15	35	350	380	22

Track profile

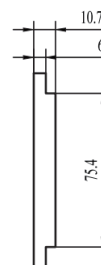
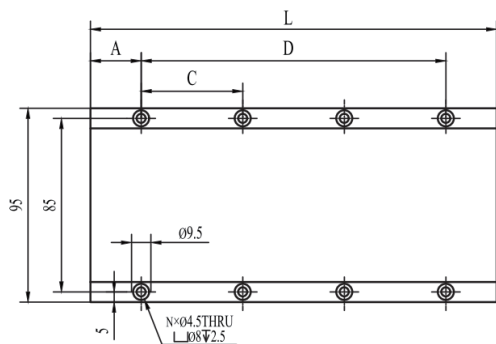

(単位:mm)	A	C	D	L	N
TMAA95-150	25	50	100	150	6
TMAA95-200	25	50	150	200	8
TMAA95-250	25	50	200	250	10

TLM series

TSLM series

TIC series

TU series

TICA115 series with iron core

41.5mm
Height

115mm
width

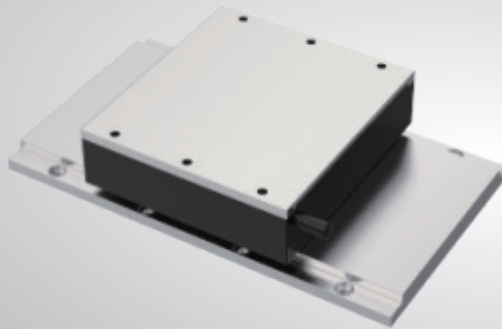

Continuous thrust **234N~702N**

Peak thrust **648N~1944N**

Temperature rise **< 0.05°C/W**

Thrust fluctuation **< 2%**

Product parameter

Motor Model	TICA115-1		TICA115-2		TICA115-3	
Winding Code	S	S	P	S	T	
Performance Parameters						
Maximum Thrust (N)	648	1296	1296	1944	1944	
Continuous Thrust (N)	234	468	468	702	702	
Maximum Power (W)	972	1944	1944	2916	2916	
Continuous Power (W)	351	702	702	1053	1053	
Forward Attraction Force (N)	1105	2210	2210	3315	3315	
Electrical Characteristics						
Maximum Current (Arms)	10.29	10.29	20.58	10.29	30.87	
Continuous Current (Arms)	3.22	3.22	6.44	3.22	9.66	
Thrust Constant (N/Arms)	72.02	144.04	72.02	216.06	72.02	
Back EMF (Vpeak/m/s)	63.56	127.12	63.56	190.68	63.56	
Line Resistance (Ohms)	4.2	8.4	2.1	12.6	1.4	
Line Inductance (mH)	27.8	55.6	13.9	83.4	9.27	
Time Constant (ms)	5.38	5.38	5.38	5.38	5.38	
Motor Constant (N/√W)	28.95	40.95	40.95	50.15	50.15	
Maximum Coil Temperature (°C)	130	130	130	130	130	
Maximum Terminal Voltage (VDC)	310	310	310	310	310	
Mechanical Characteristics						
Mover Length (mm)	105	193	193	280	280	
Mover Mass (kg)	1.8	3.4	3.4	4.6	4.6	
Stator Mass (kg/m)	8.2	8.2	8.2	8.2	8.2	
Magnetic Pole Pitch (mm)	25	25	25	25	25	

TLM series

TSLM series

TIC series

TU series

Motor outline

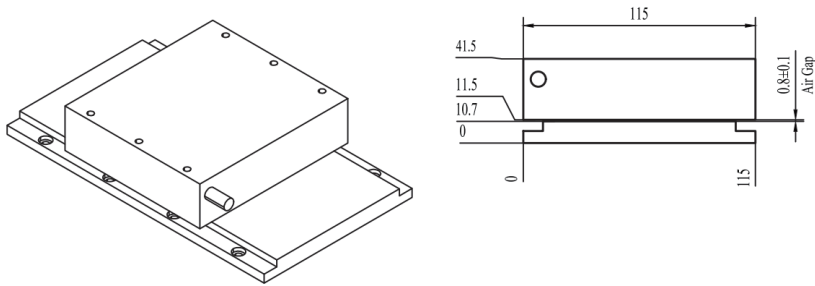

Coil profile

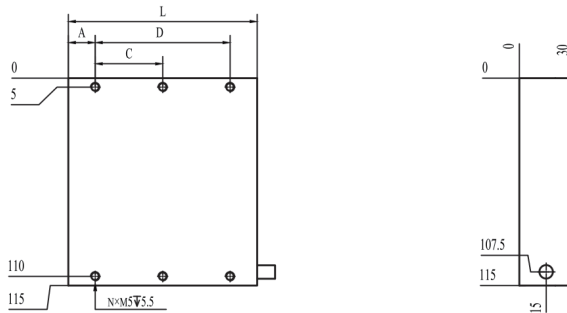

(単位:mm)	A	C	D	L	N
TICA115-1	15	37.5	75	105	6
TICA115-2	16.5	40	160	193	10
TICA115-3	20	40	240	280	14

Track profile

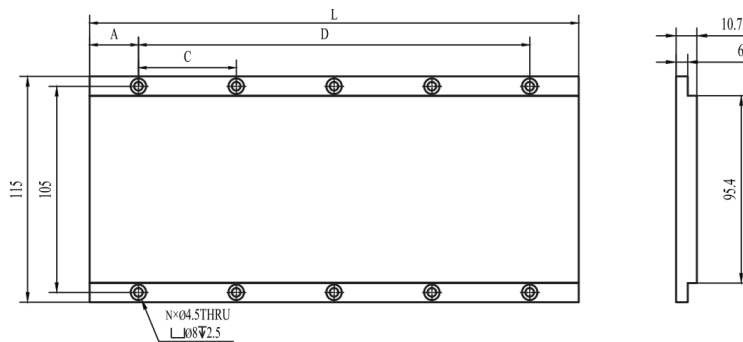

(単位:mm)	A	C	D	L	N
TMA115-150	25	50	100	150	6
TMA115-200	25	50	150	200	8
TMA115-250	25	50	200	250	10

TICA125 series with iron core

41.5mm
Height

125mm
width

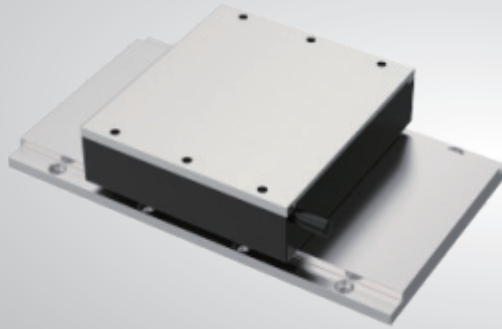

Continuous thrust **273N~819N**

Peak thrust **759N~2277N**

Temperature rise **< 0.05°C/W**

Thrust fluctuation **< 2%**

Product parameter

Motor Model	TICA125-1		TICA125-2		TICA125-3	
Winding Code	S	S	P	S	T	
Performance Parameters						
Maximum Thrust (N)	759	1518	1518	2277	2277	
Continuous Thrust (N)	273	546	546	819	819	
Maximum Power (W)	1138.5	2277	2277	3415.5	3415.5	
Continuous Power (W)	410	820	820	1230	1230	
Forward Attraction Force (N)	1221	2442	2442	3663	3663	
Electrical Characteristics						
Maximum Current (Arms)	10.28	10.28	20.56	10.28	30.84	
Continuous Current (Arms)	3.38	3.38	6.76	3.38	10.14	
Thrust Constant (N/Arms)	79.59	159.18	79.59	238.77	79.59	
Back EMF (Vpeak/m/s)	70.25	140.5	70.25	210.75	70.25	
Line Resistance (Ohms)	5.75	11.5	2.88	17.25	1.92	
Line Inductance (mH)	31.46	62.92	15.73	94.38	10.49	
Time Constant (ms)	5.47	5.47	5.47	5.47	5.47	
Motor Constant (N/√W)	27.5	38.89	38.89	47.64	47.64	
Maximum Coil Temperature (°C)	130	130	130	130	130	
Maximum Terminal Voltage (VDC)	310	310	310	310	310	
Mechanical Characteristics						
Mover Length (mm)	105	193	193	280	280	
Mover Mass (kg)	2	4.3	4.3	5.9	5.9	
Stator Mass (kg/m)	8.9	8.9	8.9	8.9	8.9	
Magnetic Pole Pitch (mm)	25	25	25	25	25	

Motor outline

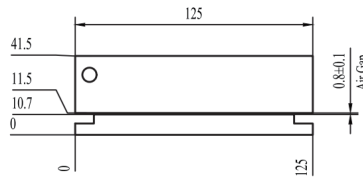
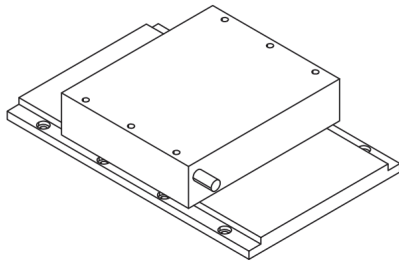

Coil profile

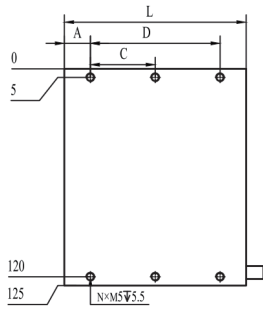

(単位:mm)	A	C	D	L	N
TICA125-1	15	37.5	75	105	6
TICA125-2	16.5	40	160	193	10
TICA125-3	20	40	240	280	14

Track profile

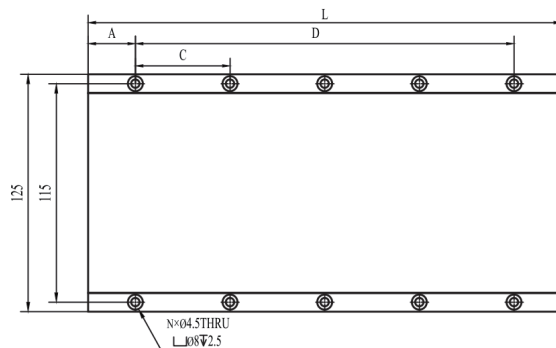

(単位:mm)	A	C	D	L	N
TMA125-150	25	50	100	150	6
TMA125-200	25	50	150	200	8
TMA125-250	25	50	200	250	10

TICA135 series with iron core

41.5mm
Height

135mm
width

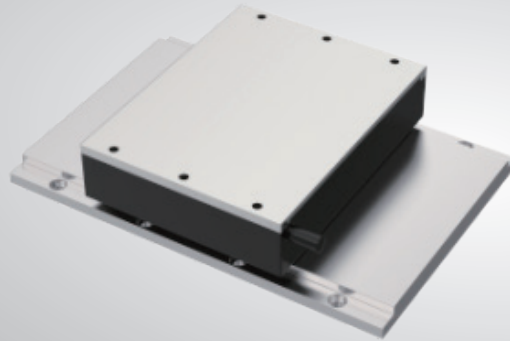

Continuous thrust **294N~882N**

Peak thrust **851N~2553N**

Temperature rise **< 0.05°C/W**

Thrust fluctuation **< 2%**

Product parameter

Motor Model	TICA135-1		TICA135-2		TICA135-3	
Winding Code	S	S	P	S	T	
Performance Parameters						
Maximum Thrust (N)	851	1702	1702	2553	2553	
Continuous Thrust (N)	294	588	588	882	882	
Maximum Power (W)	1276	2552	2552	3828	3828	
Continuous Power (W)	441	882	882	1323	1323	
Forward Attraction Force (N)	1741	3482	3482	5223	5223	
Electrical Characteristics						
Maximum Current (Arms)	10.31	10.31	20.62	10.31	30.93	
Continuous Current (Arms)	3.38	3.38	6.76	3.38	10.14	
Thrust Constant (N/Arms)	80.77	161.54	80.77	242.31	80.77	
Back EMF (Vpeak/m/s)	70.26	140.52	70.26	210.78	70.26	
Line Resistance (Ohms)	6.9	13.8	3.45	20.7	2.3	
Line Inductance (mH)	34.8	69.6	17.4	104.4	11.6	
Time Constant (ms)	4.58	4.58	4.58	4.58	4.58	
Motor Constant (N/√W)	27.04	38.24	38.24	46.83	46.83	
Maximum Coil Temperature (°C)	130	130	130	130	130	
Maximum Terminal Voltage (VDC)	310	310	310	310	310	
Mechanical Characteristics						
Mover Length (mm)	105	193	193	280	280	
Mover Mass (kg)	2	4.3	4.3	5.9	5.9	
Stator Mass (kg/m)	8.9	8.9	8.9	8.9	8.9	
Magnetic Pole Pitch (mm)	25	25	25	25	25	

Motor outline

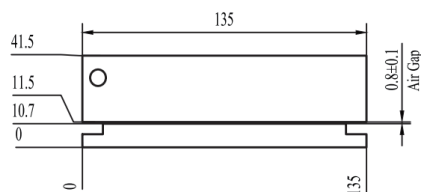
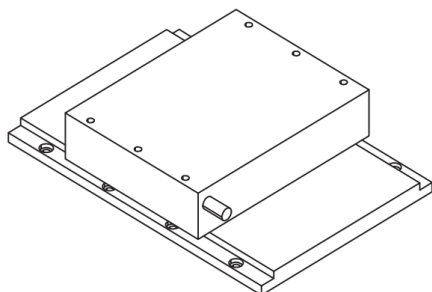

Coil profile

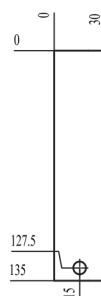
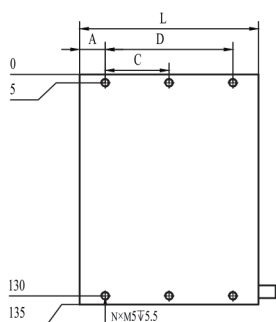

(単位:mm)	A	C	D	L	N
TICA135-1	15	37.5	75	105	6
TICA135-2	16.5	40	160	193	10
TICA135-3	20	40	240	280	14

Track profile

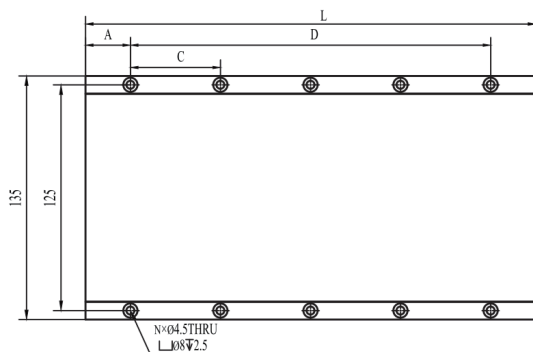

(単位:mm)	A	C	D	L	N
TMA135-150	25	50	100	150	6
TMA135-200	25	50	150	200	8
TMA135-250	25	50	200	250	10

TLM series

TSLM series

TIC series

TU series

TICG50 series with iron core

60.8mm
Height

51mm
width

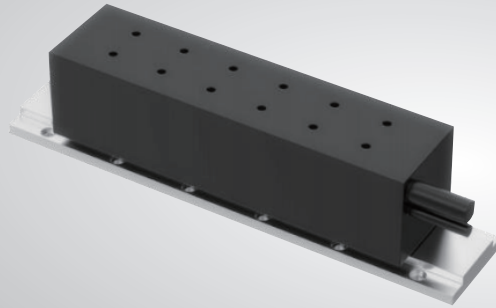

Continuous thrust **119.4N~477.6N**

Peak thrust **253.5N~1014N**

Temperature rise **< 0.06°C/W**

Thrust fluctuation **< 2%**

Product parameter

Motor Model	TICG50-1	TICG50-2	TICG50-4
Winding Code	S	S	FSP
Performance Parameters			
Maximum Thrust (N)	253.5	507	1014
Continuous Thrust (N)	119.4	238.8	477.6
Maximum Power (W)	760.5	1521	3042
Continuous Power (W)	358.2	716.4	1432.8
Forward Attraction Force (N)	390	780	1560
Electrical Characteristics			
Maximum Current (Arms)	14.52	14.52	29.04
Continuous Current (Arms)	4.84	4.84	9.68
Thrust Constant (N/Arms)	24.67	49.34	49.34
Back EMF (Vpeak/m/s)	20.31	40.63	40.63
Line Resistance (Ohms)	0.86	1.72	0.86
Line Inductance (mH)	19.8	39.6	19.8
Time Constant (ms)	23.02	23.02	23.02
Motor Constant (N/√W)	21.72	30.72	43.33
Maximum Coil Temperature (°C)	130	130	130
Maximum Terminal Voltage (VDC)	600	600	600
Mechanical Characteristics			
Mover Length (mm)	112	196	364
Mover Mass (kg)	1.5	2.7	5.1
Stator Mass (kg/m)	2.5	2.5	2.5
Magnetic Pole Pitch (mm)	42	42	42

Motor outline

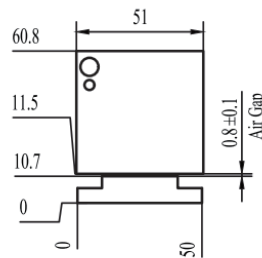
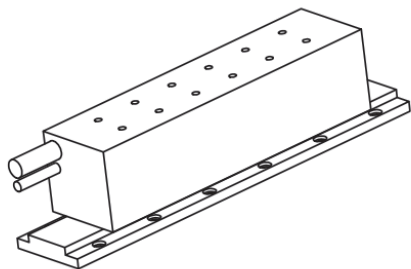

Coil profile

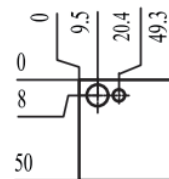
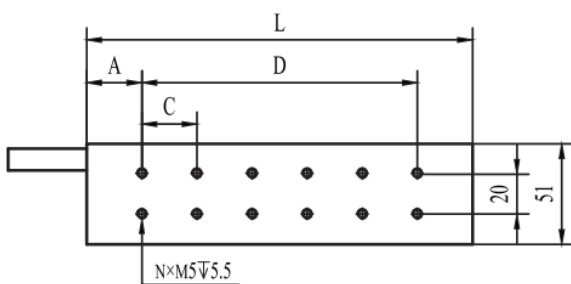

(単位:mm)	A	C	D	L	N
TICG50-1	28	28	56	112	6
TICG50-2	28	28	140	196	12
TICG50-4	28	28	308	364	24

Track profile

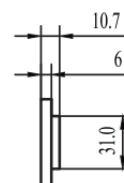
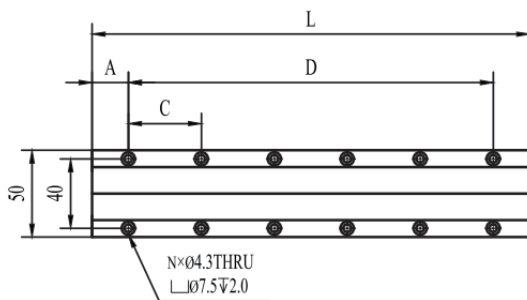

(単位:mm)	A	C	D	L	N
TMG50-168	21	42	126	168	8
TMG50-252	21	42	210	252	12
TMG50-420	21	42	378	420	20

TLM series

TSLM series

TIC series

TU series

TICG70 series with iron core

60.8mm
Height

71mm
width

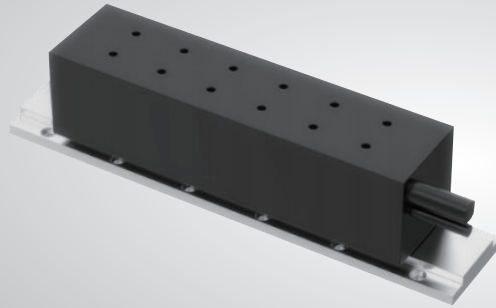

Continuous thrust **199N~796N**

Peak thrust **422.5N~1690N**

Temperature rise **< 0.06°C/W**

Thrust fluctuation **< 2%**

Product parameter

Motor Model	TICG70-1	TICG70-2	TICG70-4
Winding Code	S	S	FSP
Performance Parameters			
Maximum Thrust (N)	422.5	845	1690
Continuous Thrust (N)	199	398	796
Maximum Power (W)	1267.5	2535	5070
Continuous Power (W)	597	1194	2388
Forward Attraction Force (N)	650	1300	2600
Electrical Characteristics			
Maximum Current (Arms)	14.52	14.52	29.04
Continuous Current (Arms)	4.84	4.84	9.68
Thrust Constant (N/Arms)	41.12	82.23	82.23
Back EMF (Vpeak/m/s)	33.86	67.71	67.71
Line Resistance (Ohms)	1.27	2.54	1.27
Line Inductance (mH)	33	66	33
Time Constant (ms)	25.98	25.98	25.98
Motor Constant (N/√W)	29.79	42.13	59.58
Maximum Coil Temperature (°C)	130	130	130
Maximum Terminal Voltage (VDC)	600	600	600
Mechanical Characteristics			
Mover Length (mm)	112	196	364
Mover Mass (kg)	2.2	4.1	7.9
Stator Mass (kg/m)	4.7	4.7	4.7
Magnetic Pole Pitch (mm)	42	42	42

Motor outline

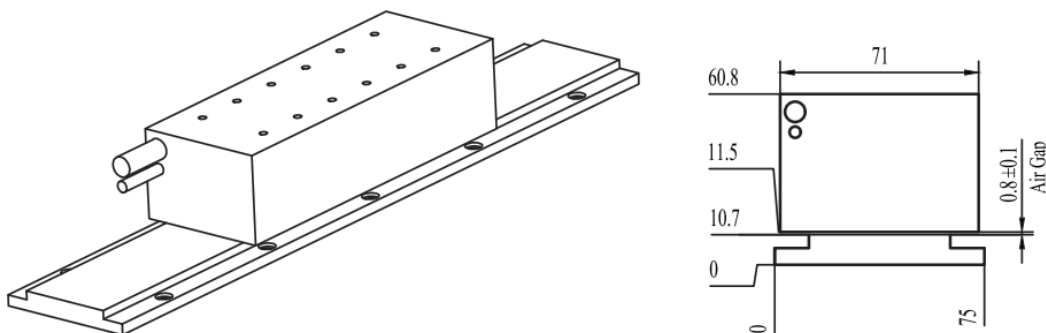

Coil profile

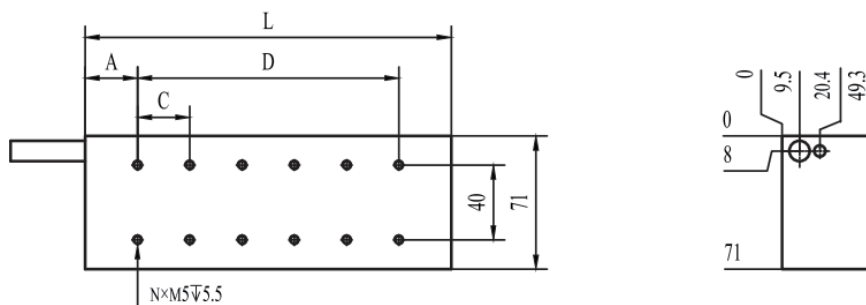

(単位:mm)	A	C	D	L	N
TICG70-1	28	28	56	112	6
TICG70-2	28	28	140	196	12
TICG70-4	28	28	308	364	24

Track profile

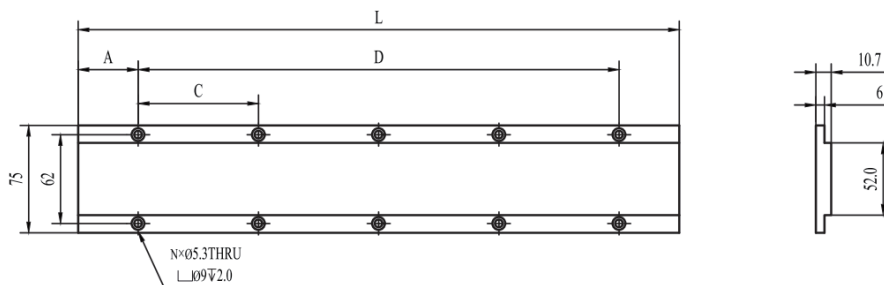

(単位:mm)	A	C	D	L	N
TMG70-168	42	84	84	168	8
TMG70-252	42	84	168	252	12
TMG70-420	42	84	336	420	20

TLM series

TSLM series

TIC series

TU series

TICG120 series with iron core

60.8mm
Height

121mm
width

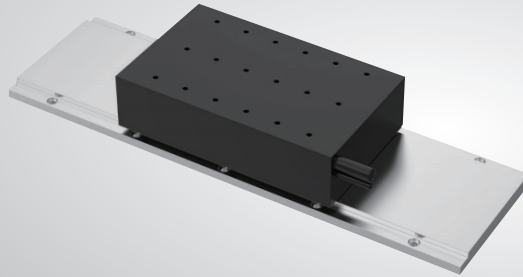

Continuous thrust **398N~1592N**

Peak thrust **845N~3380N**

Temperature rise **< 0.06°C/W**

Thrust fluctuation **< 2%**

Product parameter

Motor Model	TICG120-1	TICG120-2	TICG120-4
Winding Code	S	S	FSP
Performance Parameters			
Maximum Thrust (N)	845	1690	3380
Continuous Thrust (N)	398	796	1592
Maximum Power (W)	2535	5070	10140
Continuous Power (W)	1194	2388	4776
Forward Attraction Force (N)	1300	2600	5200
Electrical Characteristics			
Maximum Current (Arms)	14.52	14.52	29.04
Continuous Current (Arms)	4.84	4.84	9.68
Thrust Constant (N/Arms)	82.23	164.46	164.46
Back EMF (Vpeak/m/s)	67.71	135.43	135.43
Line Resistance (Ohms)	2.3	4.6	2.3
Line Inductance (mH)	66	132	66
Time Constant (ms)	28.7	28.7	28.7
Motor Constant (N/√W)	44.27	62.61	88.54
Maximum Coil Temperature (°C)	130	130	130
Maximum Terminal Voltage (VDC)	600	600	600
Mechanical Characteristics			
Mover Length (mm)	112	196	364
Mover Mass (kg)	4	7	13.5
Stator Mass (kg/m)	8.5	8.5	8.5
Magnetic Pole Pitch (mm)	42	42	42

Motor outline

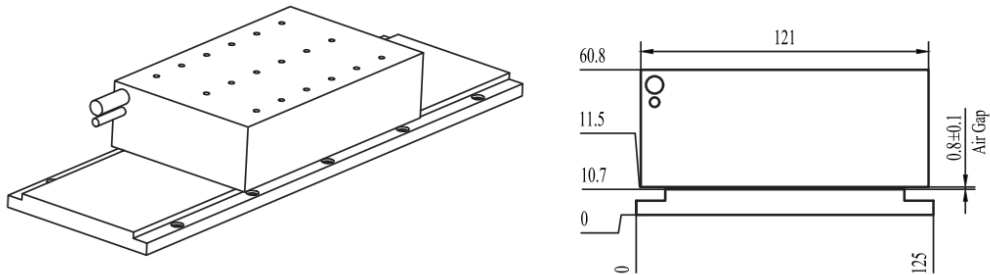

Coil profile

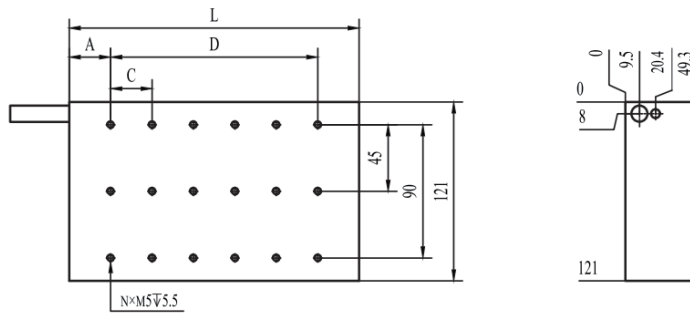

(単位:mm)	A	C	D	L	N
TICG120-1	28	28	56	112	9
TICG120-2	28	28	140	196	18
TICG120-4	28	28	308	364	36

Track profile

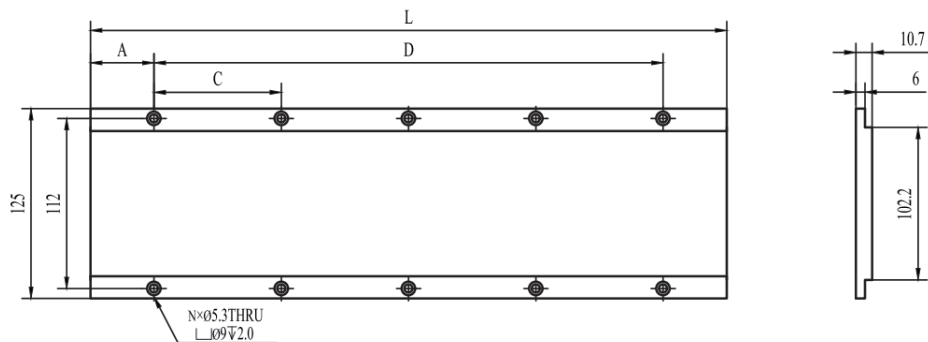

(単位:mm)	A	C	D	L	N
TMG70-168	42	84	84	168	8
TMG70-252	42	84	168	252	12
TMG70-420	42	84	336	420	20

TICG170 series with iron core

60.8mm
Height

171mm
width

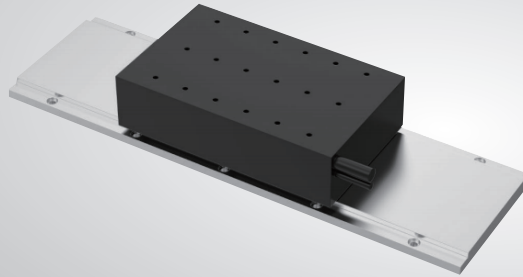

Continuous thrust **2388N~4776N**

Peak thrust **5070N~10140N**

Temperature rise **< 0.06°C/W**

Thrust fluctuation **< 2%**

Product parameter

Motor Model	TICG170-4	TICG170-8
Winding Code	P	P
Performance Parameters		
Maximum Thrust (N)	5070	10140
Continuous Thrust (N)	2388	4776
Maximum Power (W)	15210	30420
Continuous Power (W)	7164	14328
Forward Attraction Force (N)	7800	15600
Electrical Characteristics		
Maximum Current (Arms)	29.04	58.08
Continuous Current (Arms)	9.68	19.36
Thrust Constant (N/Arms)	246.69	246.69
Back EMF (Vpeak/m/s)	203.14	203.14
Line Resistance (Ohms)	3.33	1.665
Line Inductance (mH)	99	49.5
Time Constant (ms)	29.73	29.73
Motor Constant (N/√W)	110.38	156.1
Maximum Coil Temperature (°C)	130	130
Maximum Terminal Voltage (VDC)	600	600
Mechanical Characteristics		
Mover Length (mm)	364	700
Mover Mass (kg)	20.2	39.4
Stator Mass (kg/m)	15.1	15.1
Magnetic Pole Pitch (mm)	42	42

Motor outline

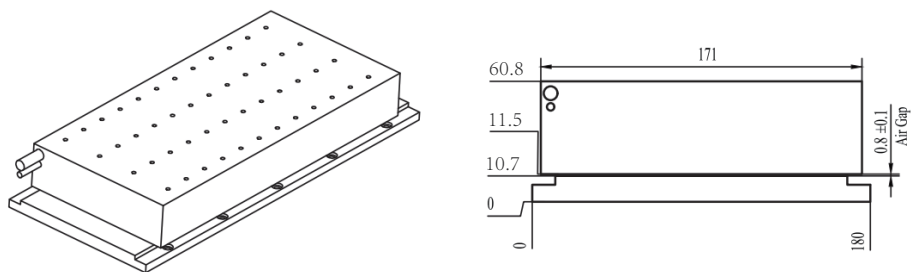

Coil profile

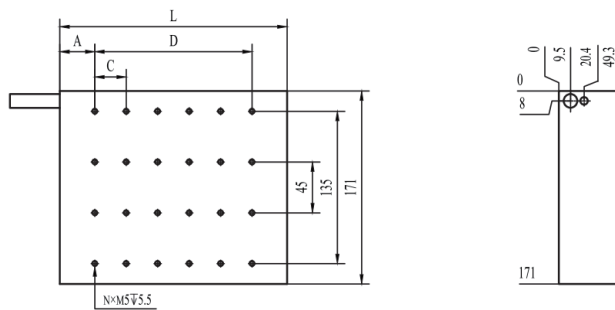

(単位:mm)	A	C	D	L	N
TICG170-4	28	28	308	364	48
TICG170-8	28	28	644	700	96

Track profile

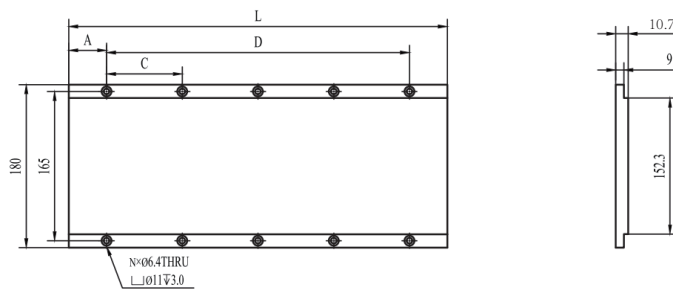

(単位:mm)	A	C	D	L	N
TMG170-168	42	84	84	168	8
TMG170-252	42	84	168	252	12
TMG170-420	42	84	336	420	20

TLM series

TSLM series

TIC series

TU series

TICG220 series with iron core

60.8mm
Height

221mm
width

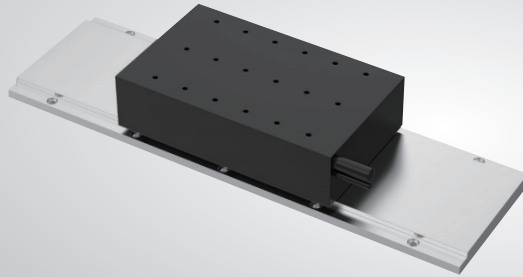

Continuous thrust **3184N~6368N**

Peak thrust **6760N~13520N**

Temperature rise **< 0.06°C/W**

Thrust fluctuation **< 2%**

Product parameter

Motor Model	TICG220-4	TICG220-8
Winding Code	P	P
Performance Parameters		
Maximum Thrust (N)	6760	13520
Continuous Thrust (N)	3184	6368
Maximum Power (W)	20280	40560
Continuous Power (W)	9552	19104
Forward Attraction Force (N)	10400	20800
Electrical Characteristics		
Maximum Current (Arms)	29.04	58.08
Continuous Current (Arms)	9.68	19.36
Thrust Constant (N/Arms)	328.93	328.93
Back EMF (Vpeak/m/s)	270.85	270.85
Line Resistance (Ohms)	4.36	2.18
Line Inductance (mH)	132	66
Time Constant (ms)	30.28	30.28
Motor Constant (N/√W)	128.62	181.9
Maximum Coil Temperature (°C)	130	130
Maximum Terminal Voltage (VDC)	600	600
Mechanical Characteristics		
Mover Length (mm)	364	700
Mover Mass (kg)	26.5	51.6
Stator Mass (kg/m)	22.3	22.3
Magnetic Pole Pitch (mm)	42	42

Motor outline

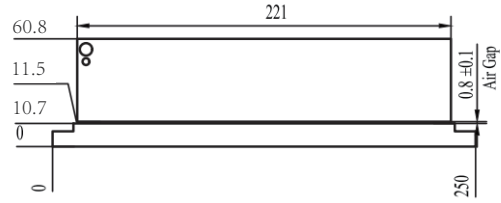
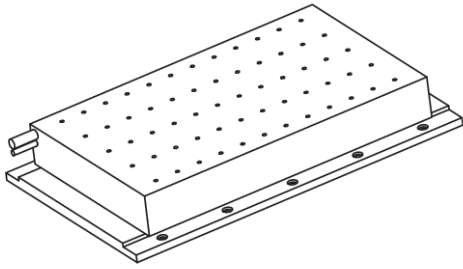

Coil profile

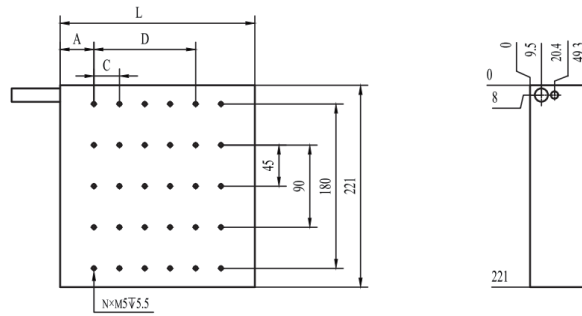

(単位:mm)	A	C	D	L	N
TICG220-4	28	28	308	364	60
TICG220-8	28	28	644	700	120

Track profile

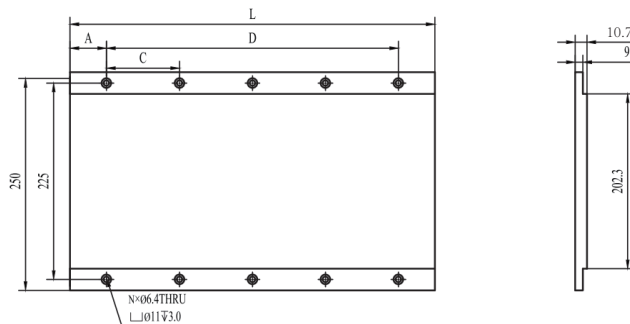

(単位:mm)	A	C	D	L	N
TMG220-168	42	84	84	168	4
TMG220-252	42	84	168	252	6
TMG220-420	42	84	336	420	10